

Blockhaus 40 (480x480)

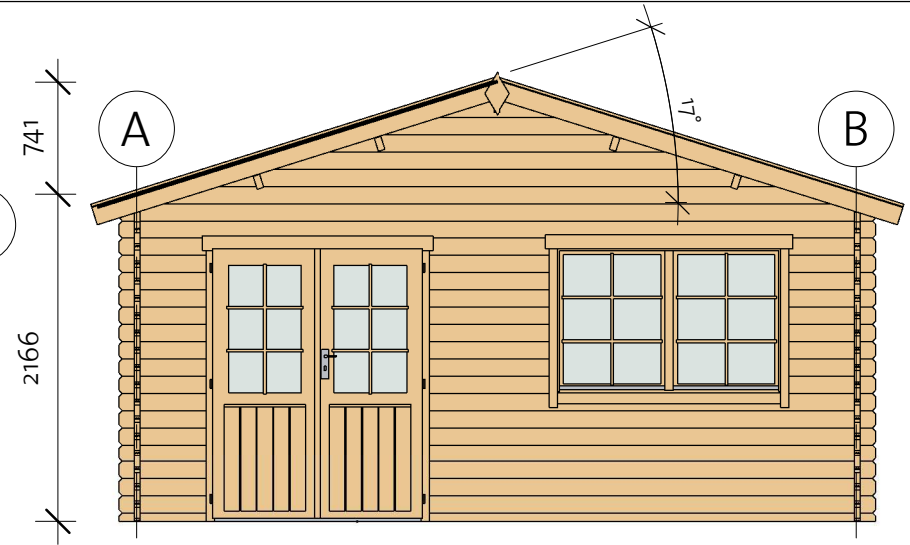

Blockhaus 40 (480x480)

Floor Plan

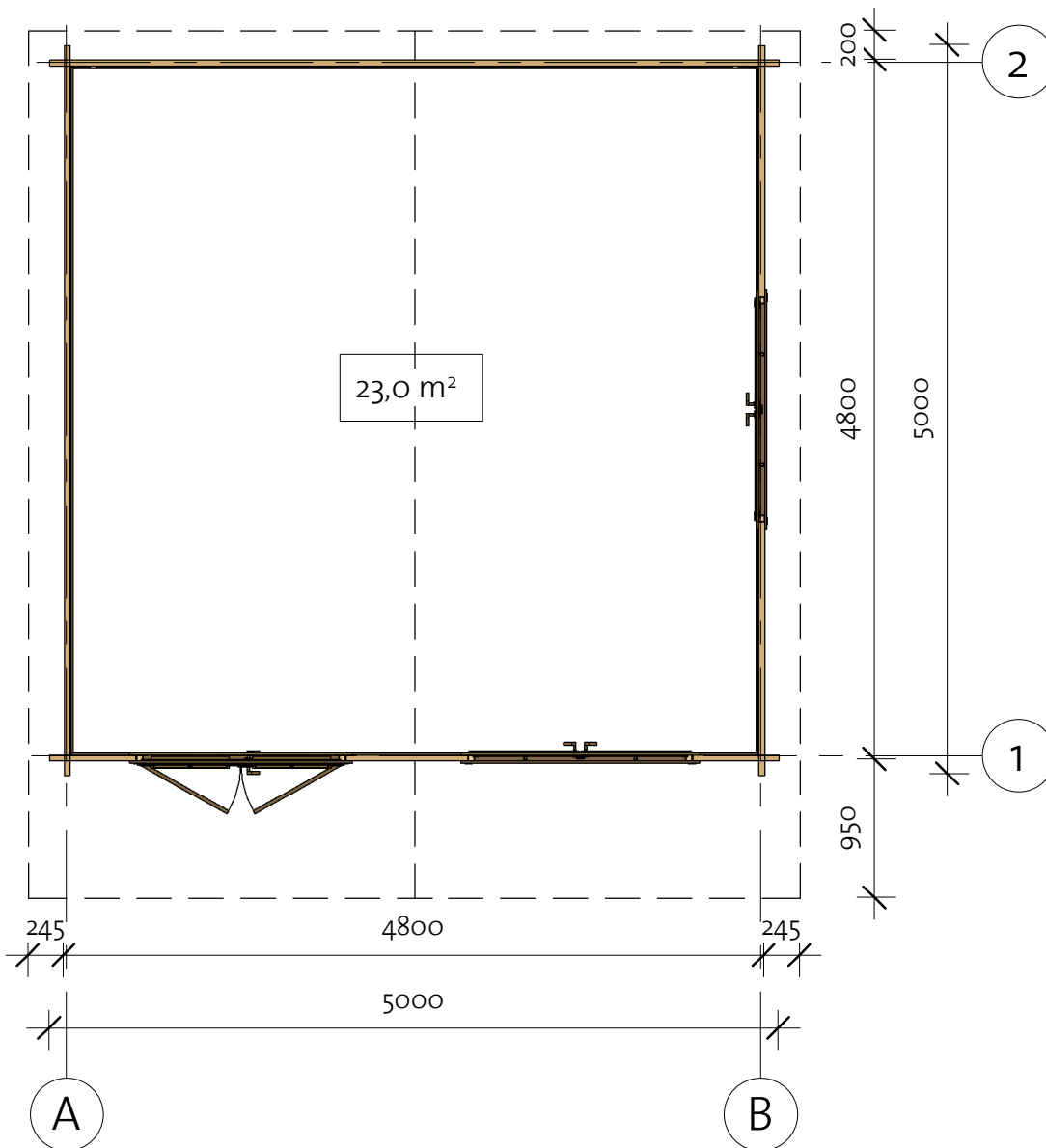
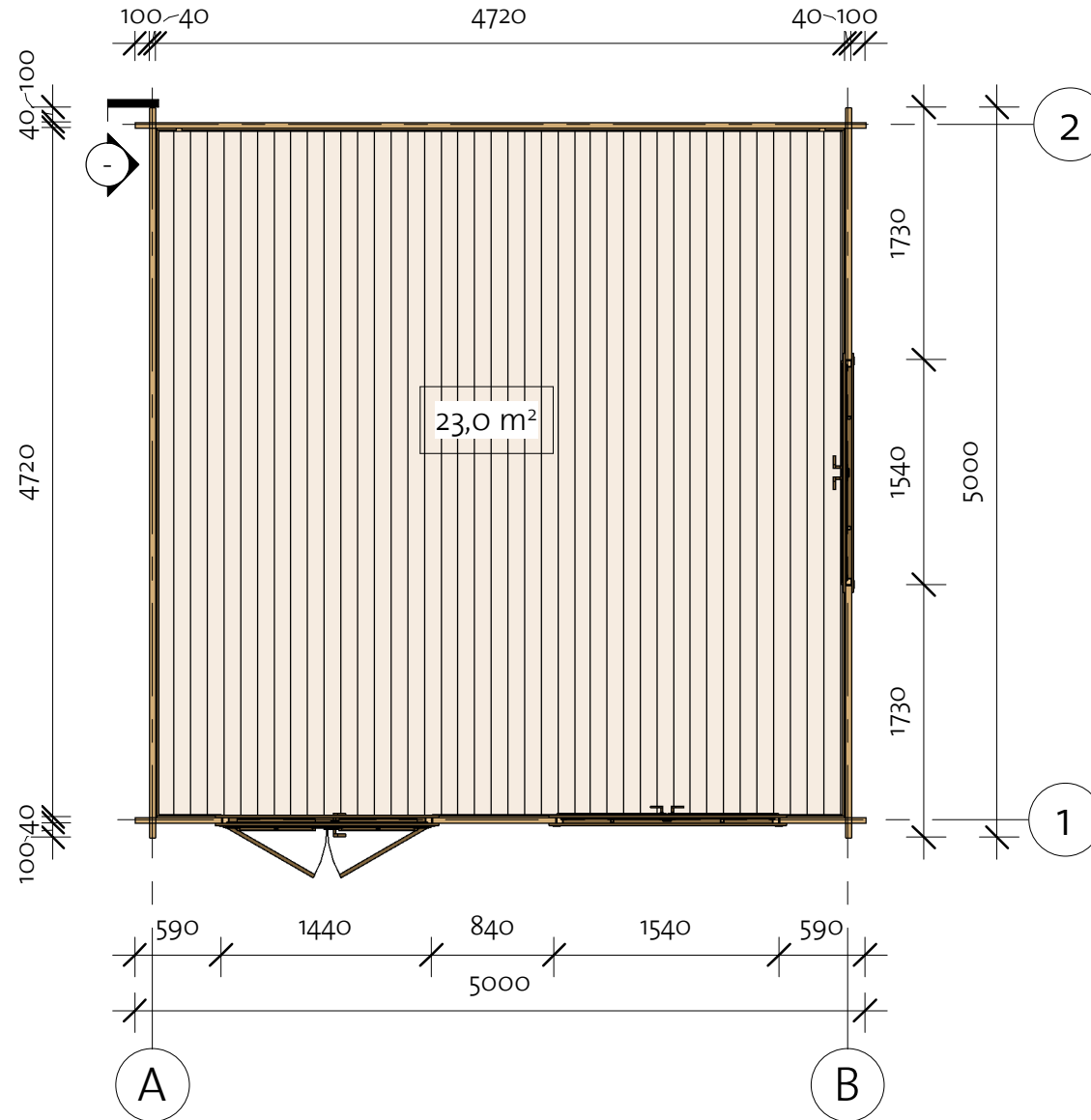

Blockhaus 40 (480x480)

Wall 1

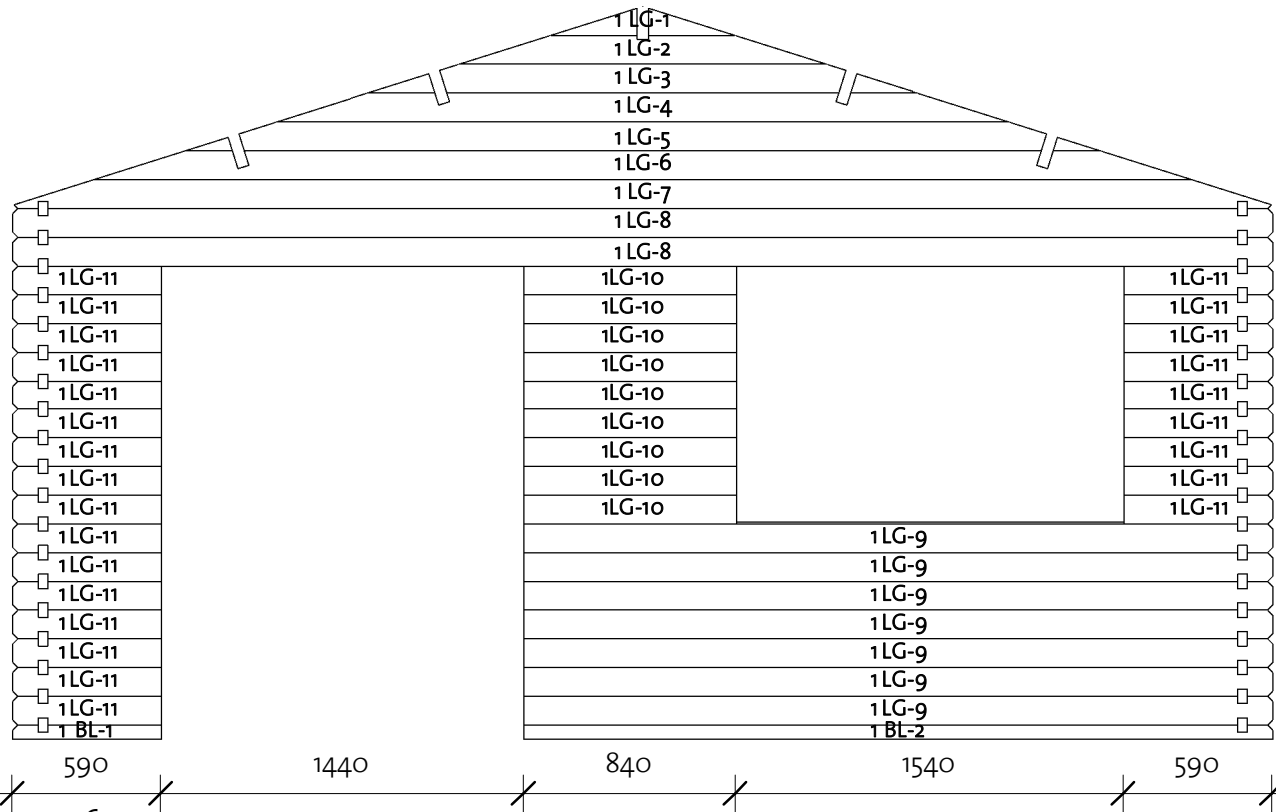
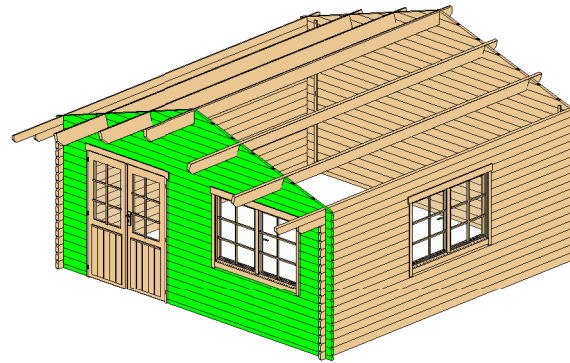

91919112_220601



Wall 1

Mark	Profile	Count	Cut Length
------	---------	-------	------------

1BL-1	40x57	1	590
1BL-2	40x57	1	2970
1LG-1 *	40x114	1	727
1LG-2 *	40x114	1	1453
1LG-3 *	40x114	1	2179
1LG-4 *	40x114	1	2905
1LG-5 *	40x114	1	3631
1LG-6 *	40x114	1	4357
1LG-7 *	40x114	1	4989
1LG-8	40x114	2	5000
1LG-9	40x114	7	2970
1LG-10	40x114	9	840
1LG-11	40x114	25	590

* Gable - delivered premounted

Log Profile Wall 1

Profile	Profile
40x57	
40x114	

Blockhaus 40 (480x480)

Wall 2

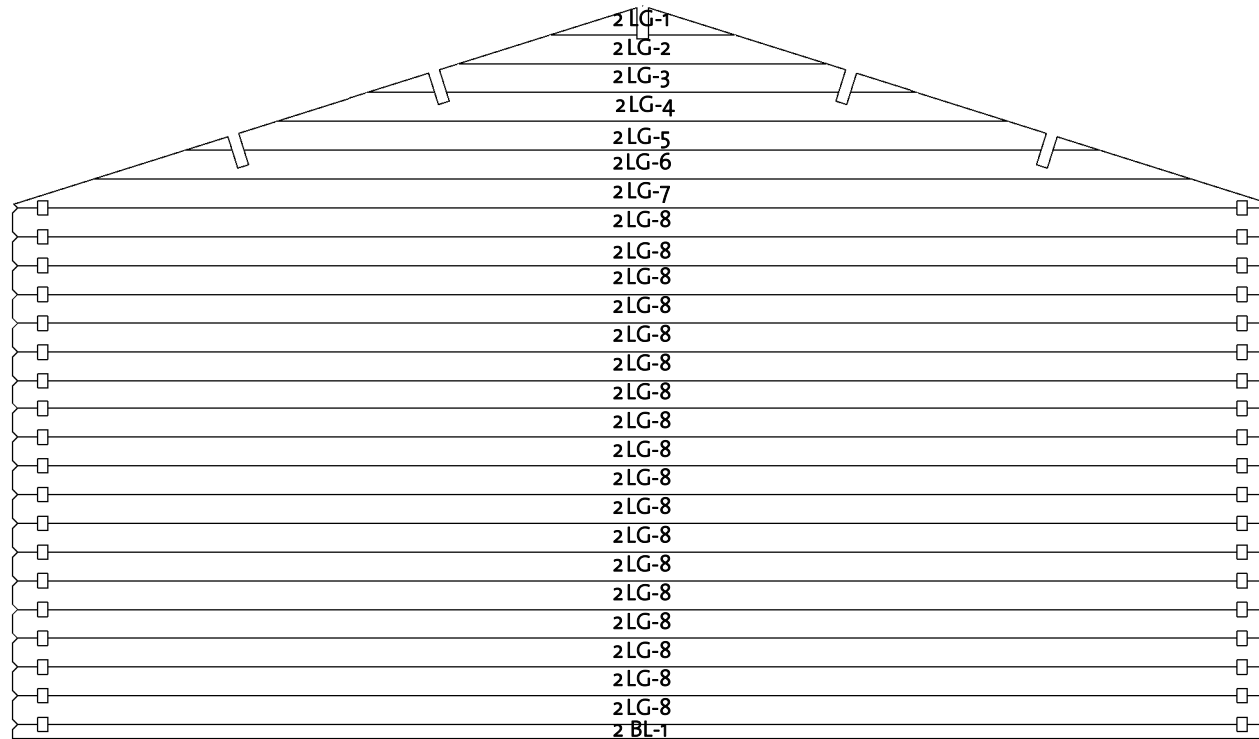
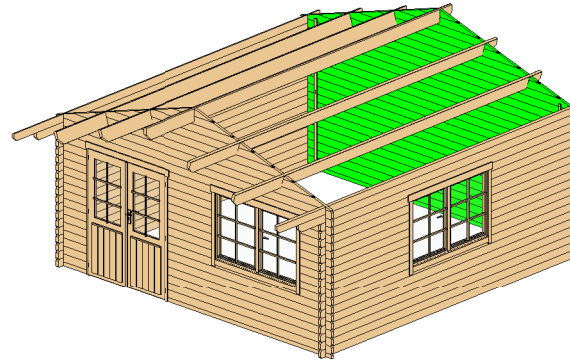

Wall 2

Mark	Profile	Count	Cut Length
------	---------	-------	------------

2BL-1	40x57	1	5000
2LG-1*	40x114	1	727
2LG-2*	40x114	1	1453
2LG-3*	40x114	1	2179
2LG-4*	40x114	1	2905
2LG-5*	40x114	1	3631
2LG-6*	40x114	1	4357
2LG-7*	40x114	1	4989
2LG-8	40x114	18	5000

* Gable - delivered premounted

Log Profile Wall 2

Profile	Profile
---------	---------

40x57



40x114



Blockhaus 40 (480x480)

Wall A

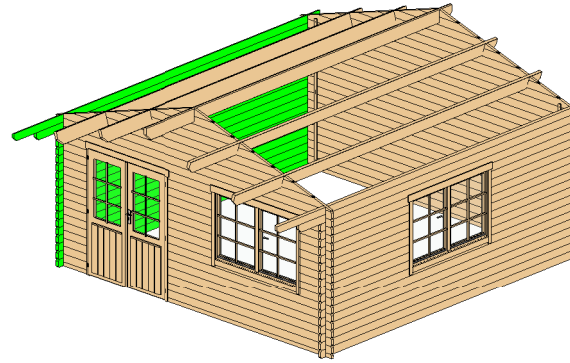

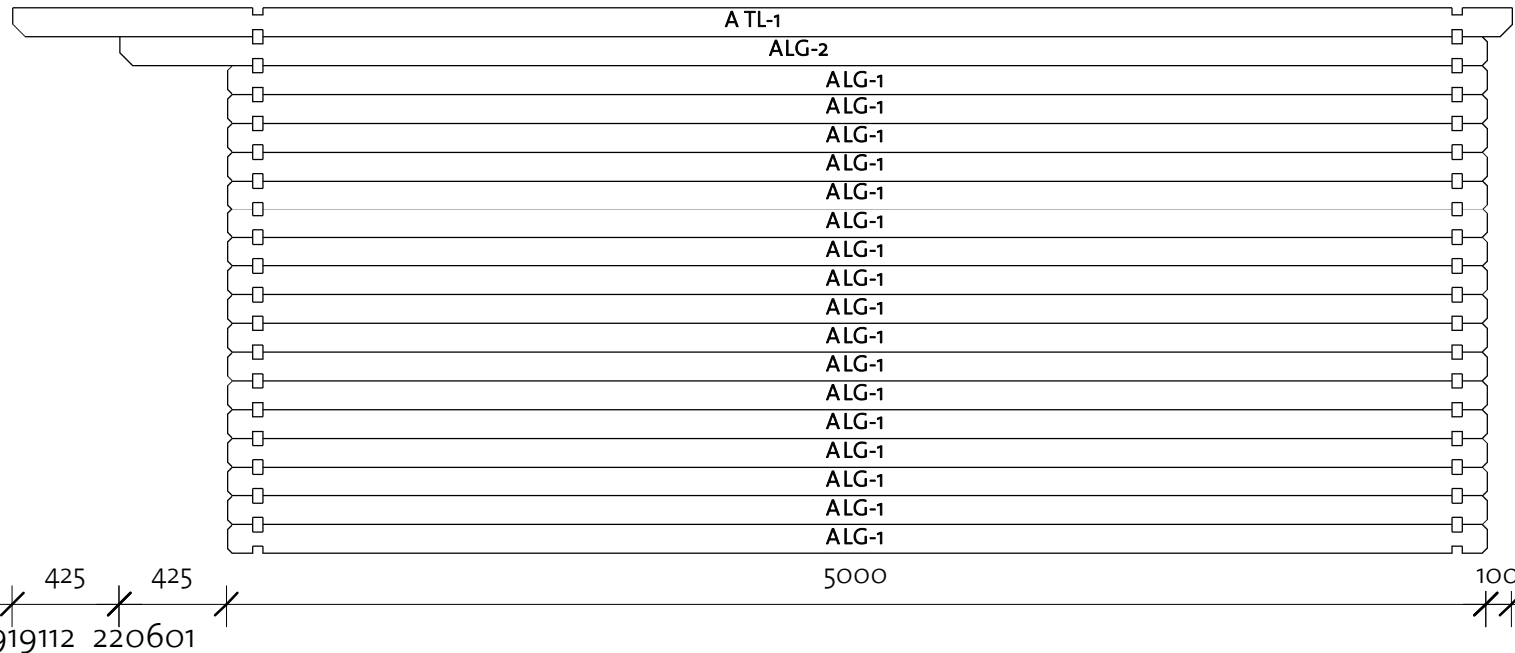

Wall A			
Mark	Profile	Count	Cut Length

ALG-1	40x114	17	5000
ALG-2	40x114	1	5425
ATL-1	40x114	1	5950



Log Profile Wall A	
Profile	Profile

40x114	
40x114	

Blockhaus 40 (480x480)

Wall B

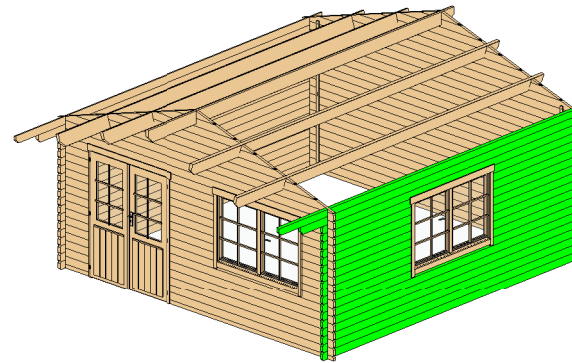

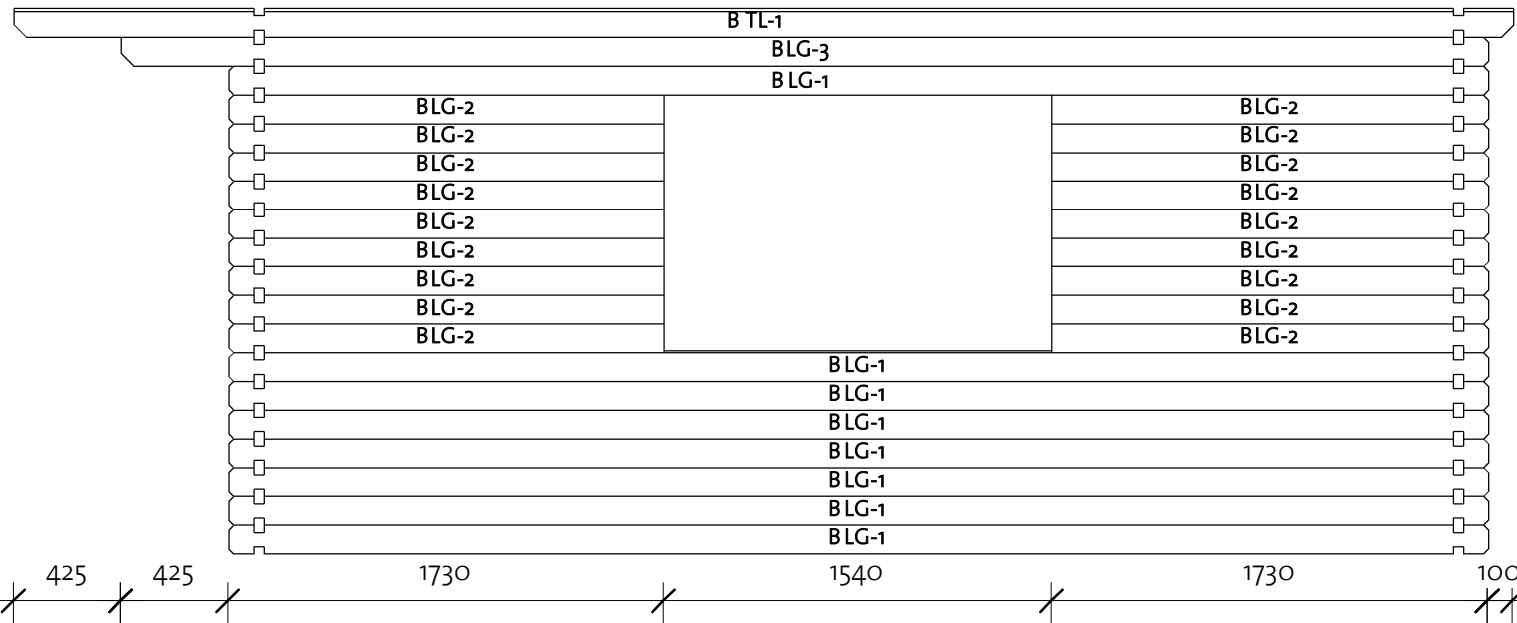

Wall B			
Mark	Profile	Count	Cut Length

BLG-1	40x114	8	5000
BLG-2	40x114	18	1730
BLG-3	40x114	1	5425
BTL-1	40x114	1	5950



91919112_220601



Log Profile Wall B	
Profile	Profile

40x114	
40x114	

Blockhaus 40 (480x480)

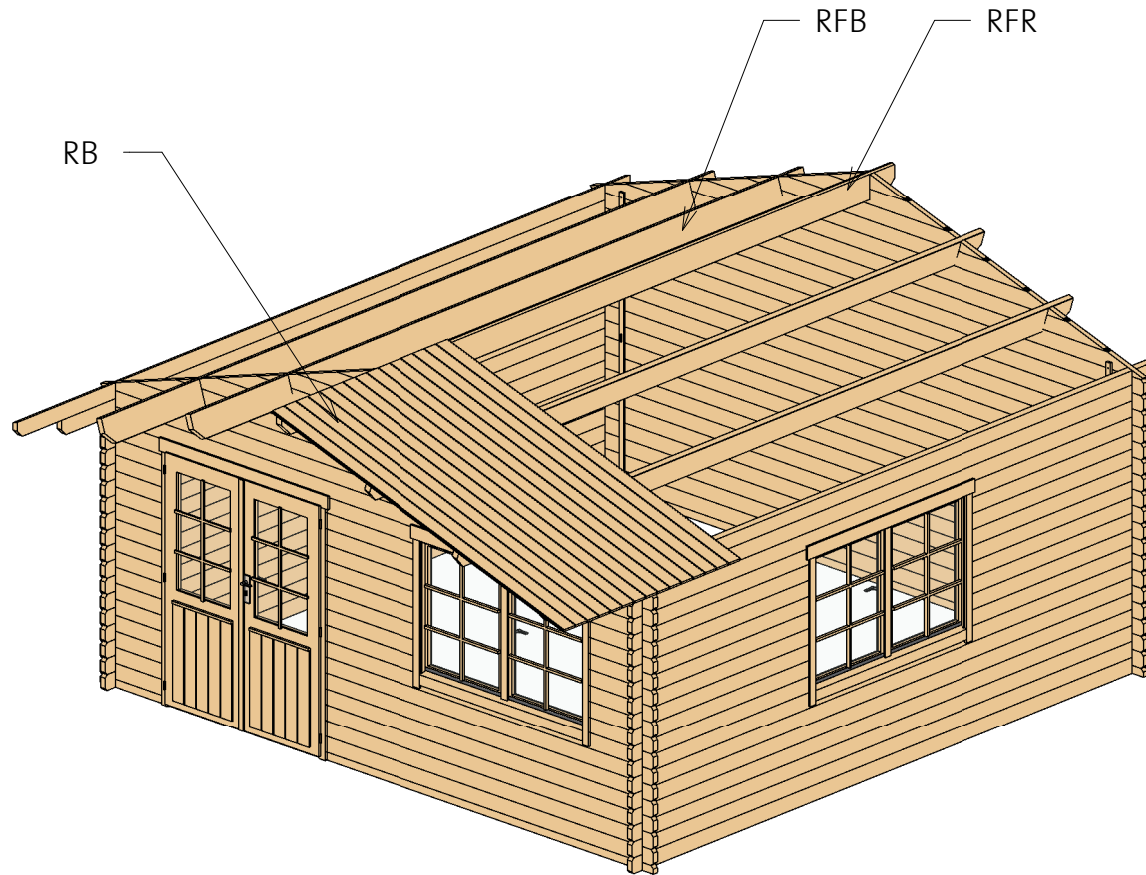
Roof 1



Roof				
Mark	Type	Profile	Count	Length
RFR	Ridge 45x195		1	5950
RFB	Beam 45x195		4	5950
RB	17x114		106	2767

Blockhaus 40 (480x480)

Roof 2

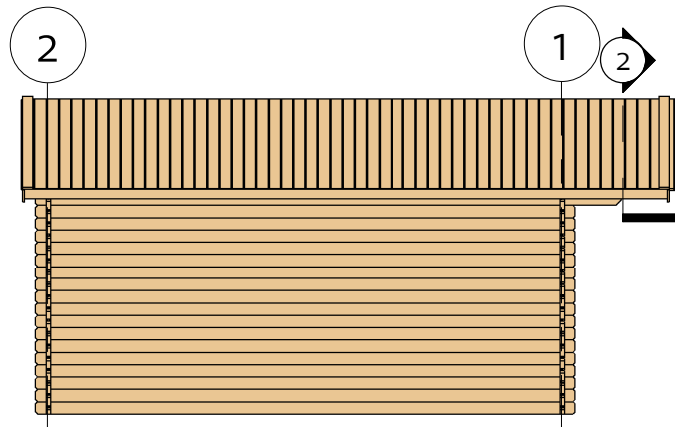

② Facia

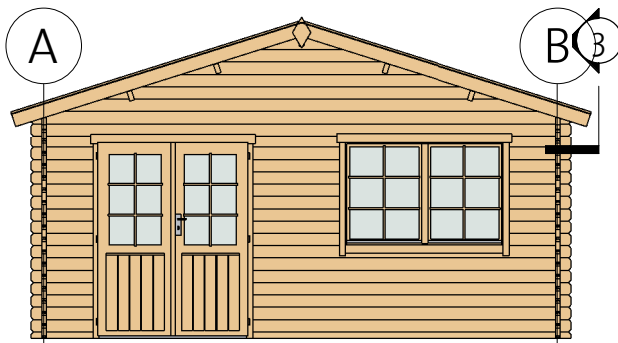
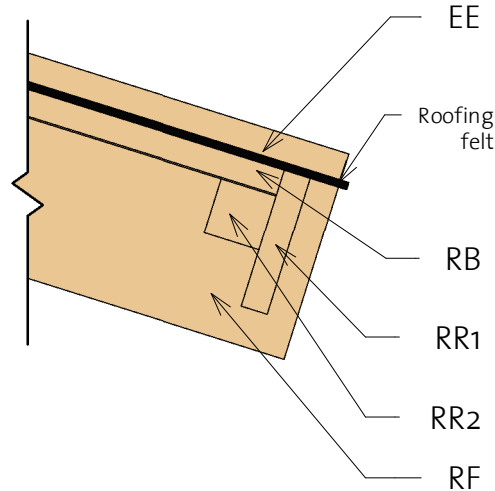

③ Roof Reinforcement

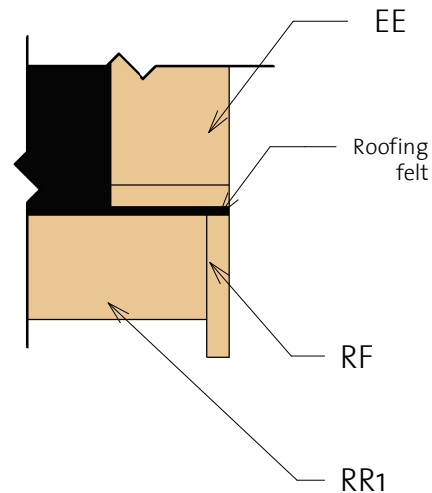











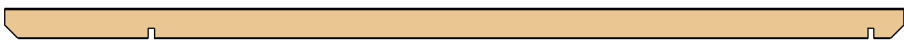







Fascia Schedule

Mark	Type	Profile	Count	Length
EE	Eave Edging 18x95		4	2810
RF	Roof Fascia 18x120		4	2810
RR1	Roof reinforce ment 18x95		2	5950
RR2	Roof reinforce ment 38x38		2	5950

Blockhaus 40 (480x480)

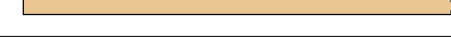
List of all items 1

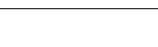
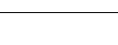
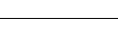
	RFB	Beam 45x195			4	5950
	RFR	Ridge 45x195			1	5950
A	TL-1	Log 40x114			1	5950
B	TL-1	Log 40x114			1	5950
A	LG-2	Log 40x114			1	5425
B	LG-3	Log 40x114			1	5425
2	BL-1	Log 40x57			1	5000
A	LG-1	Log 40x114			17	5000
B	LG-1	Log 40x114			8	5000
1	LG-8	Log 40x114			2	5000
2	LG-8	Log 40x114			18	5000
1	BL-2	Log 40x57			1	2970
1	LG-9	Log 40x114			7	2970
	RB	17x114			106	2767
B	LG-2	Log 40x114			18	1730
1	LG-10	Log 40x114			9	840
1	BL-1	Log 40x57			1	590
1	LG-11	Log 40x114			25	590





Windboard 18x40		4	2200
--------------------	---	---	------

Romb	2	
------	---	---

91919112_220601

Blockhaus 40 (480x480)

List of all items 2

RR1	Roof reinforcement 18x95		2	5950
RR2	Roof reinforcement 38x38		2	5950
EE	Eave Edging 18x95		4	2810
RF	Roof Fascia 18x120		4	2810

CDD12R	Classic double door 12 right	1425	1835	1
--------	------------------------------	------	------	---

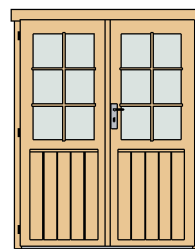



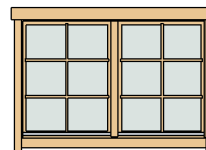

DCB6	Door Crossbar 6	--	--	2
------	-----------------	----	----	---

CDW1	Classic double window 1	1530	990	2
------	-------------------------	------	-----	---



WCB6	Windows Crossbar 6	--	--	4
------	--------------------	----	----	---

Hitblock	300-400 mm		
Screws	5,0 x 70		10
Bolts	M8x70		12
Screws	6,0 x 140		25
Screws	4,0 x 40		600

① Gable 1

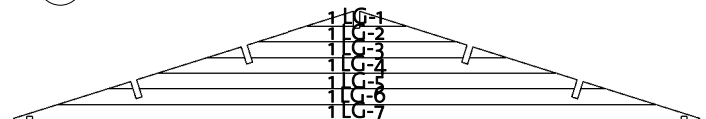

② Gable 2

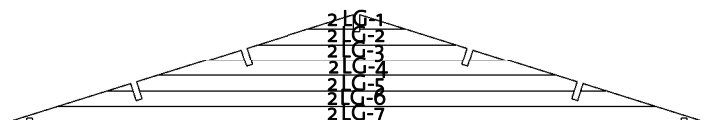

BB	BB 20x40		4	4800
----	----------	--	---	------